



CUSTOM EDITIONS



2023 CATALOGUE

INDEX

AN ORIGINAL BRAND	1
THE WORLD OF MOLESKINE®	2
CUSTOM EDITIONS	4
CUSTOMIZATION	5
CUSTOMIZATION TECHNIQUES	6
CLASSIC NOTEBOOK POCKET	8
CLASSIC NOTEBOOK LARGE	10
CLASSIC NOTEBOOK X-LARGE	12
CLASSIC NOTEBOOK EXPANDED	14
CLASSIC NOTEBOOK MEDIUM	15
CAHIER JOURNALS	16
PASSION JOURNAL	18
GIFTBOX MOLESKINE	19
SMART WRITING SET	20
BUSINESS BACKPACK	21



AN ORIGINAL BRAND

A cultural icon

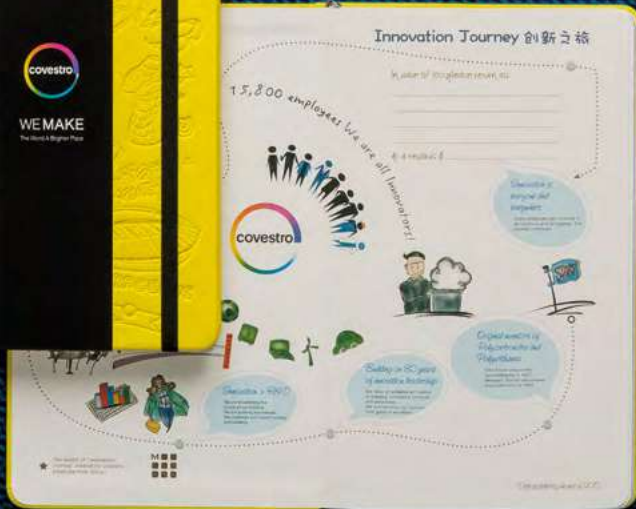
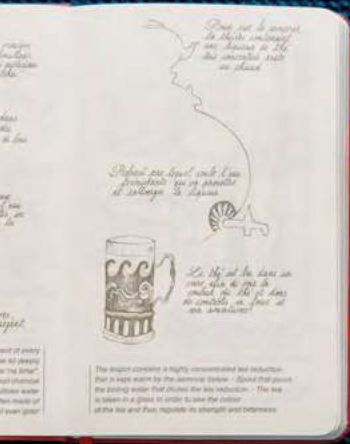



THE WORLD OF MOLESKINE®

THE LEGENDARY NOTEBOOK

The Moleskine® notebook is the heir and successor to the legendary notebook used by artists and thinkers over the past two centuries: among them Vincent Van Gogh, Pablo Picasso, Ernest Hemingway and Bruce Chatwin.

Today, it is celebrated in pop culture as a contemporary icon, an inviting blank space where your own words and sketches join you to an ever-evolving relay of creativity.



OUR MANIFESTO

At Moleskine® we believe in the timeless power of handwriting as an essential expression of human civilization, a powerful act to unleash human genius and foster the development and sharing of literacy and knowledge. In a fast-paced technological era, we proudly celebrate the artistry of the human touch; the enduring pleasure of putting pen to paper to unleash your unique voice. We celebrate the solemn, thoughtful and meditative gesture of the pen gliding across a blank page; the romance of crafting a personal story to record a lifelong memory and leave a distinguishing mark in all its unique beauty. Handwriting is both universal and deeply personal. It's a thoughtful way to express your true self and connect to others in a very intimate yet universally accessible way.

Put pen to paper, and unleash your unique voice.



WRITE YOUR STORY

"Every Moleskine® notebook is a book yet to be written and a story waiting to be told."

Maria Sebregondi, Moleskine® co-founder and president of Moleskine® Foundation.



A CREATIVE HISTORY

In his book *The Songlines*, Chatwin tells the story of the little black notebook: in 1986, the manufacturer, a small family-owned company in the French city of Tours, went out of business. "Le vrai moleskine n'est plus" are the lapidary words he puts into the mouth of the owner of the stationery shop in Rue de l'Ancienne Comédie where he usually purchased his notebooks. Chatwin set about buying up all the notebooks that he could find before his departure for Australia, but they were still not enough.

In 1997, the company known today as Moleskine® brought the legendary notebook back to life.

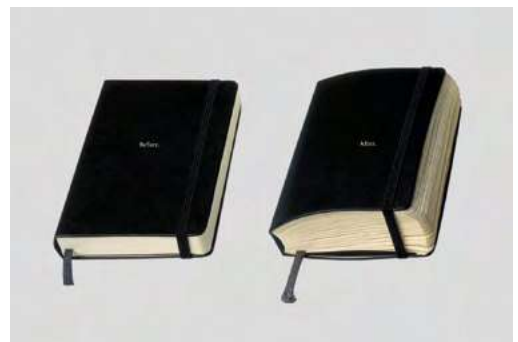

myMOLESKINE COMMUNITY

A community of artists with a shared love of paper and Moleskine®. myMoleskine is a living library of Moleskine-inspired creations. It has 365k subscribed members and 24k artworks uploaded.



FOLD MAGAZINE

Fold Magazine represents the brand's cultural core: each story explores ideas, people and places at the forefront of contemporary culture.



CREATIVE TOOLS FOR SOCIAL CHANGE

A long-term program to support creative organizations around the world. Creative Tools for Social Change empowers underserved communities by providing creative tools to foster self-expression and nurture creative thinking. CT4SC is a joint Moleskine® Foundation and Moleskine® company initiative.



MOLESKINE® FOUNDATION

Moleskine® Foundation is a non-profit organization that believes access to creativity and quality education is the key to producing systemic social change.

The Foundation uses unconventional education to encourage marginalized youth to access creative skills — unlocking their potential and transforming their communities.





CUSTOM EDITIONS

Every company has a story let us tell yours

In today's crowded world, it's not necessarily the product or service which helps a company to stand out, it's the story. A heritage accumulated over generations. It is the way a company innovates in response to challenges that differentiates it from its competitors.

Moleskine® helps companies tell their stories.



SELLING THROUGH STORYTELLING

It is always the right occasion to create a Moleskine® Custom Edition, whether you would like to resell a customized unique item, organizing a **training event** for your employees, **gifting to your clients**, partners or associates, communicating the **launch of a new product** or looking for ways to **strengthen the identity of your brand**.

WHY CHOOSE MOLESKINE®?

Moleskine® is an **iconic global brand** with a rich **cultural and artistic heritage** that is synonymous with classic-contemporary **design**. The items that it creates are not only well crafted long lasting premium and beautiful gifts but also deeply tied to its values of personal identity, memory and imagination.





CUSTOMIZATION

Start your project, start telling your story

Our notebooks are books to be written, our bags are containers to be filled and our writing instruments fuel to communicate. We offer simple, thoughtfully designed, functional items that can be turned into powerful communicators for the world's best brands.

Start telling your story.

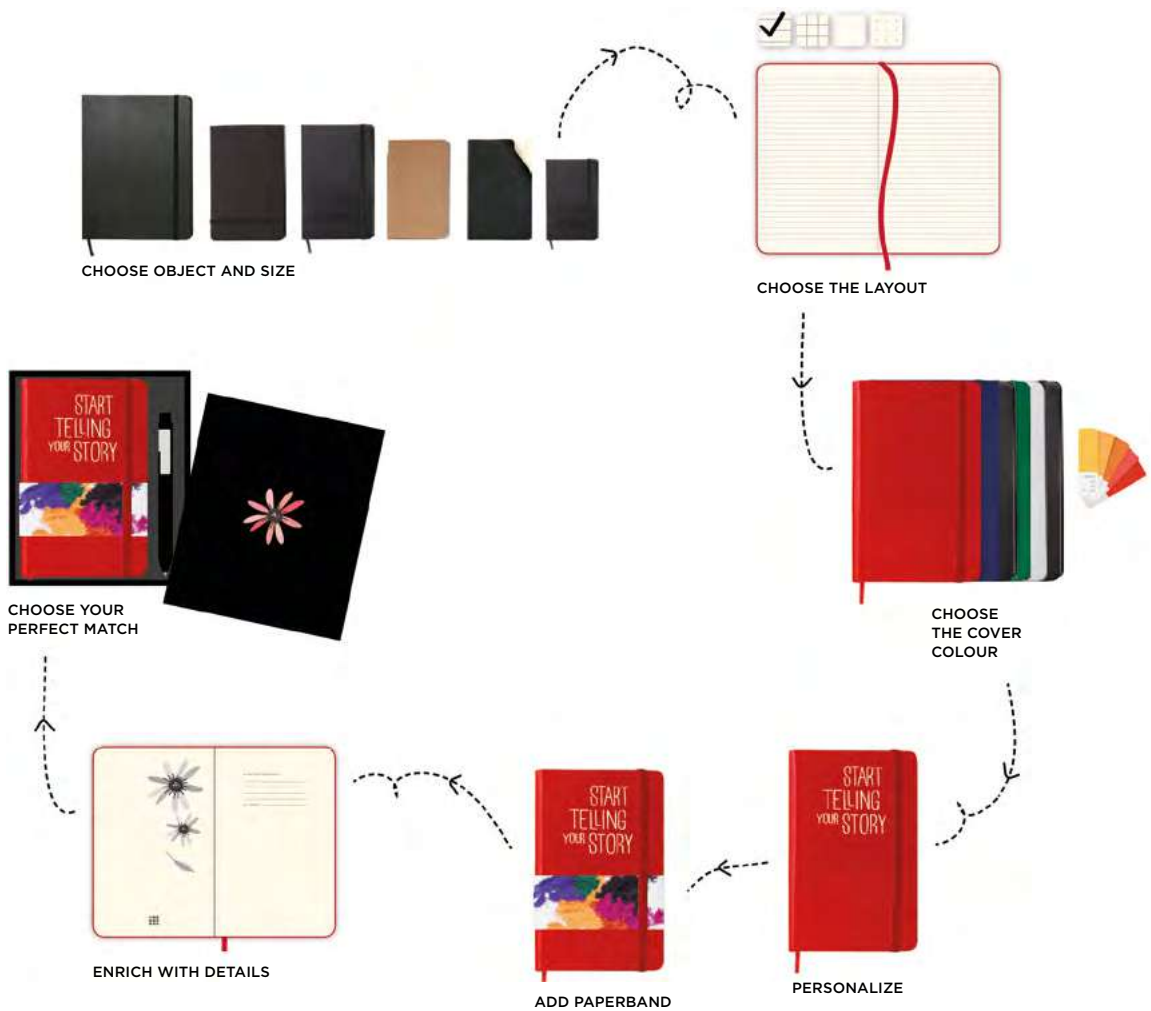



CUSTOMIZATION TECHNIQUES

There are many ways to apply a company identity to Moleskine® items, from classic printing techniques to the latest technological advances. You can discover more about each below.

Note: when printing with debossing and silkscreen, results may vary. Our team will help you make the best technical decision to communicate your story.

DEBOSSING

Like foil debossing, this technique creates a strong indentation which can be felt. No colour foil is added so the notebook retains its original colour, creating an elegant yet discreet effect.



SCREEN PRINTING

Also called serigraphy, this is one of the oldest printing methods still in use today and results in bright, eye-catching colours. It can replicate almost any colour and therefore we always use it in printing logos and company colours.

Despite some technical restrictions, this method works well with from one to four colours.

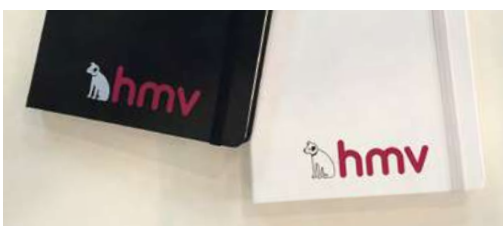

HOT STAMPING

This is the same technique that has been used for thousands of years to decorate objects using gold leaf. It creates an indentation which can be felt and the result is striking and elegant. It is available for custom editions in a range of colours including metallic colours (commonly gold, silver, copper or bronze).



BRITEPIX™

This is a newer technique that allows us to reproduce full colour text and images, except metallic colours, on a variety of surfaces. Despite having some restrictions, it is a great way to replicate more challenging images.



OFFSET

This technique has largely substituted letterpress and lithography due to its higher quality, faster turnover, and lower production costs. It is a paper printing technique that Moleskine® uses for all of our paper add-ons such as inserts, paper-bands, flyers and gift boxes.

It is available only on paper add-ons and ad hoc projects.



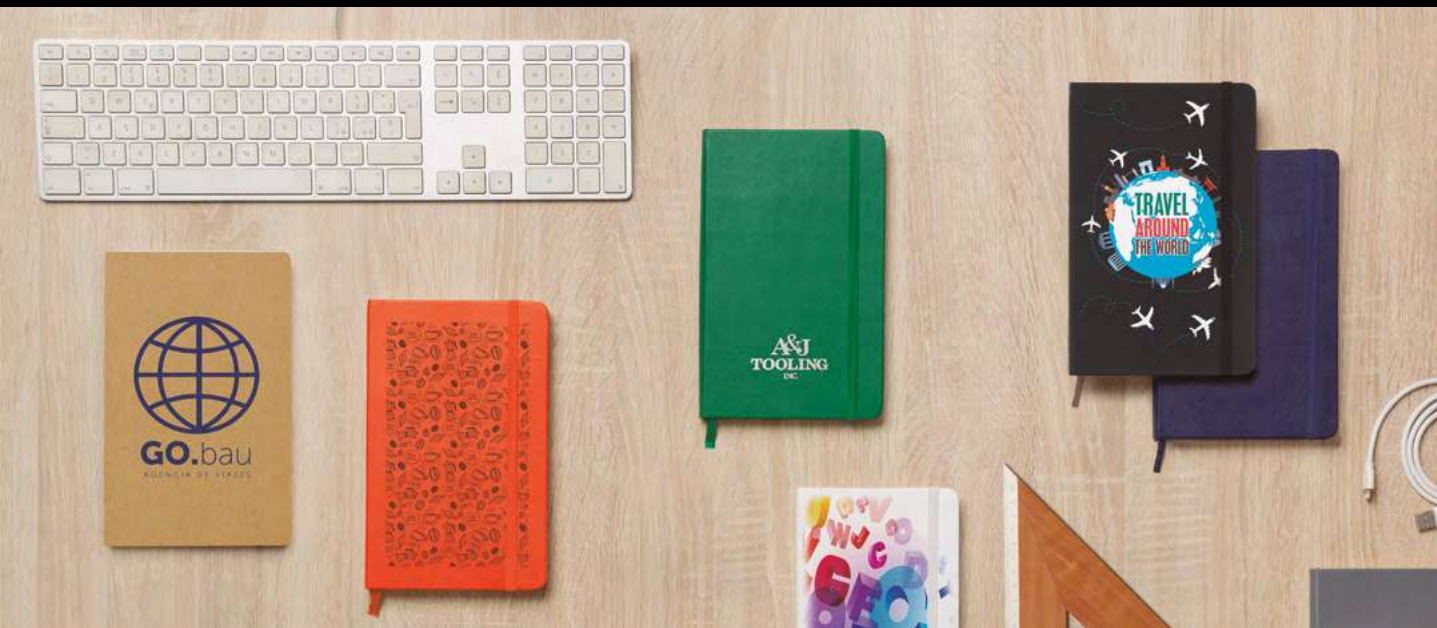

MAKE YOUR EVENTS ON THE MOVE

Your brand will be associated with:

- > Imagination: Moleskine® notebooks are open platforms for creativity; great artists have drafted their ideas in them!
- > Personal identity: A Moleskine® notebook becomes an integral part of one's personality. It's a compact and intelligent tool that helps to convey our personalities, expressing our interests and tastes.
- > A cultural icon: A Moleskine® notebook ties its owner to a heritage in art, literature and culture at large.
- > High quality: Moleskine® notebooks follow a careful process of manufacturing with a quality finish.

MOLESKINE® MAKES THE DIFFERENCE

You can identify a Moleskine Notebook by the following elements:



- > Elastic closure
- > Ribbon bookmark
- > Inner pocket made of cardboard and fabric
- > Rounded corners
- > Front endpaper with "In case of loss" notice
- > Ivory-coloured paper, FSC certified

FOR EVERY OCCASION!

- > Brand identity activities
- > Media
- > Conferences and congresses
- > Training
- > Internal communications
- > Corporate gifts
- > Incentive programs



CLASSIC NOTEBOOK POCKET 9 X 14 CM

HARD COVER - 15054  

SOFT COVER - 15096 

Classic and elegant



BLACK



BLACK



*A pocket notebook,
an ideal format to
carry everywhere!*

HARD COVER - 15054 



BLACK



SAPPHIRE
BLUE



SCARLET
RED*



PRUSSIAN
BLUE*

HARD COVER - 15054 



BLACK

SOFT COVER - 15096 



BLACK

OTHER OPTIONS UNDER REQUEST



WHITE



SAPPHIRE
BLUE

*While stocks last

Minimum order quantity 25 v.

Customization:

- A SP:** max. 1 col.
- B DB:** Transparent
- C BP:** britePix™
- D DG:** Paperband, CMYK
- E HS:** max. 1 col.

Hard cover pocket
15054

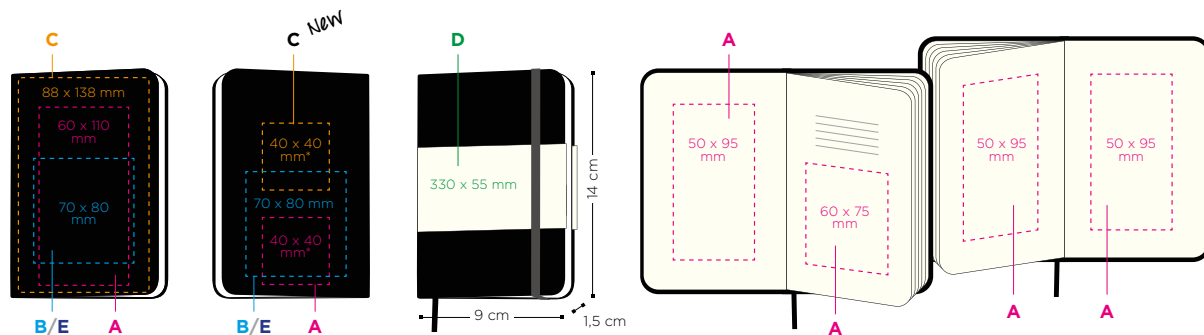

Soft cover pocket
15096

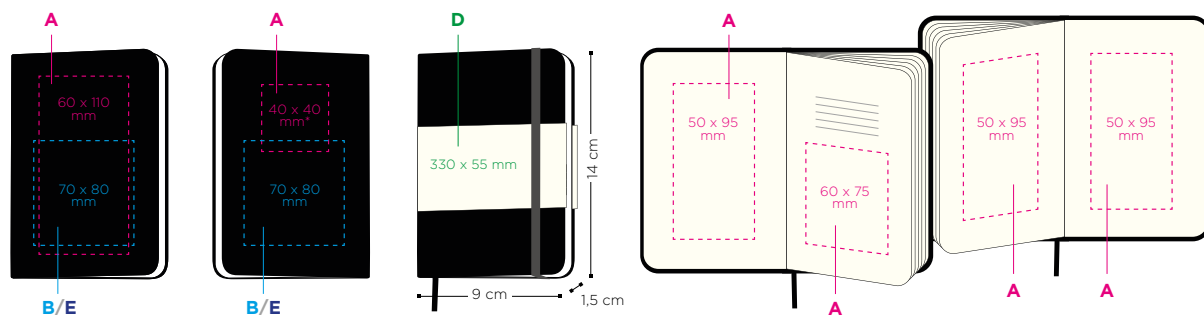

*The position or height of the printing areas may vary. Please request further information.

Interior pages:



Ivory-coloured 70 g/m² paper

Printing techniques:

SP	DB	DG	BP	HS	<ul style="list-style-type: none"> BLACK GOLD (871 C) SILVER (877 C) WHITE TRANSPARENT 	
(SP) SCREEN PRINTING	(DB) DEBOSSING	(DG) 4-COLOUR PROCESS	(BP) britePix™	(HS) HOT STAMPING		



CLASSIC NOTEBOOK LARGE 13 X 21 CM

HARD COVER - 15056

SOFT COVER - 15065



SCARLET RED



BLACK

Paperband: choose between standard and personalised!

HARD COVER - 15056



HARD COVER - 15056



SOFT COVER - 15065



SOFT COVER - 15065



OTHER OPTIONS UNDER REQUEST



*While stocks last

Minimum order quantity 25 v.

Customization:

- A SP:** max. 1 col.
- B DB:** Transparent
- C BP:** britePix™
- D DG:** Paperband, CMYK
- E HS:** max. 1 col.

Hard cover large
15056

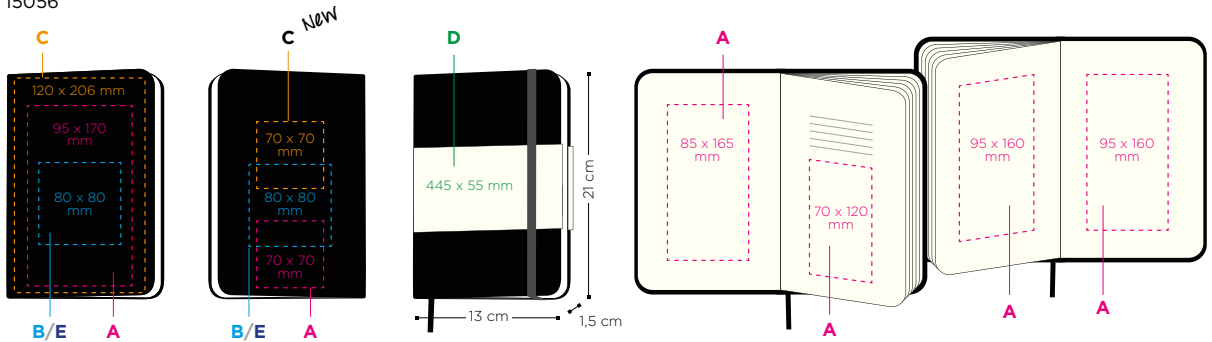

Soft cover large
15065

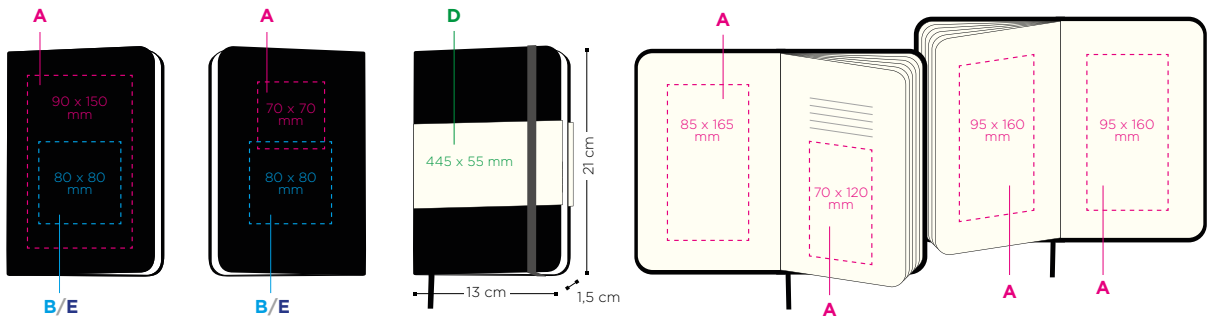

Interior pages:

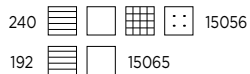

Ivory-coloured 70 g/m² paper

Printing techniques:

SP	DB	DG	BP	HS	<ul style="list-style-type: none"> BLACK GOLD (871 C) SILVER (877 C) WHITE TRANSPARENT 	
(SP) SCREEN PRINTING	(DB) DEBOSSING	(DG) 4-COLOUR PROCESS	(BP) britePix™	(HS) HOT STAMPING		





CLASSIC NOTEBOOK X-LARGE 19 X 25 CM

HARD COVER - 15097

SOFT COVER - 15094

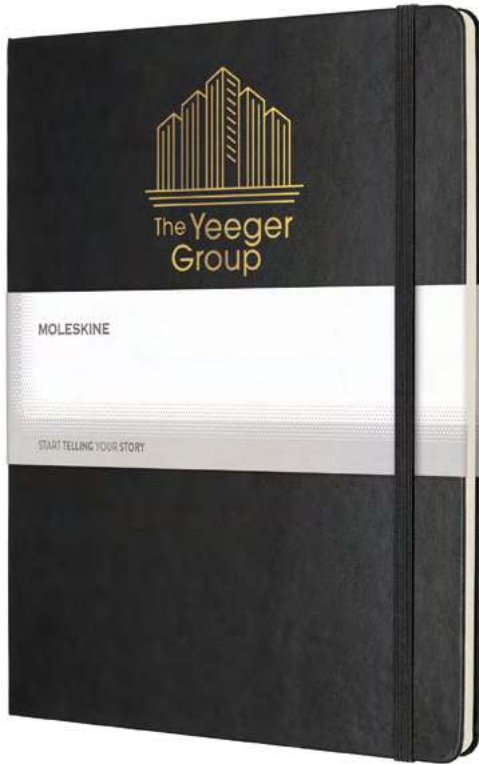

BLACK



BLACK

*X-Large format
for your great ideas!*

HARD COVER - 15097

SOFT COVER - 15094



BLACK SAPHIRE BLUE PRUSSIAN BLUE* WHITE*



BLACK SAPHIRE BLUE

OTHER OPTIONS UNDER REQUEST



SCARLET RED PLAIN PAPER DOTTED PAPER



REEF BLUE SCARLET RED DOTTED PAPER SQUARED PAPER

*While stocks last

Minimum order quantity 25 v.

Customization:

- A SP:** max. 1 col.
- B DB:** Transparent
- C DG:** Paperband, CMYK
- D HS:** max. 1 col.

Hard cover X-Large
15097

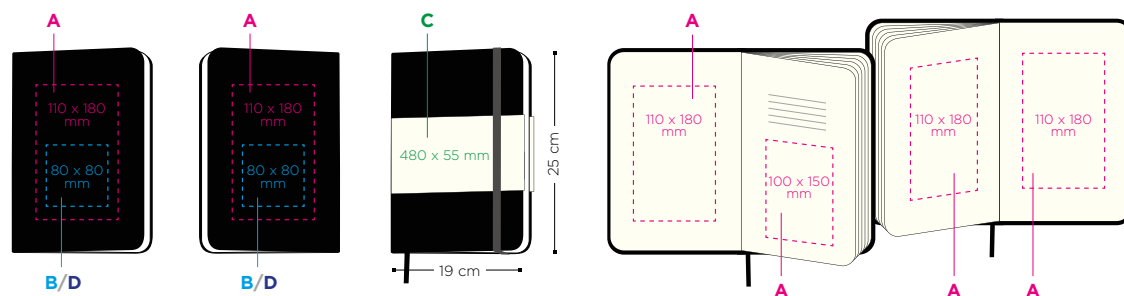

Soft cover X-Large
15094

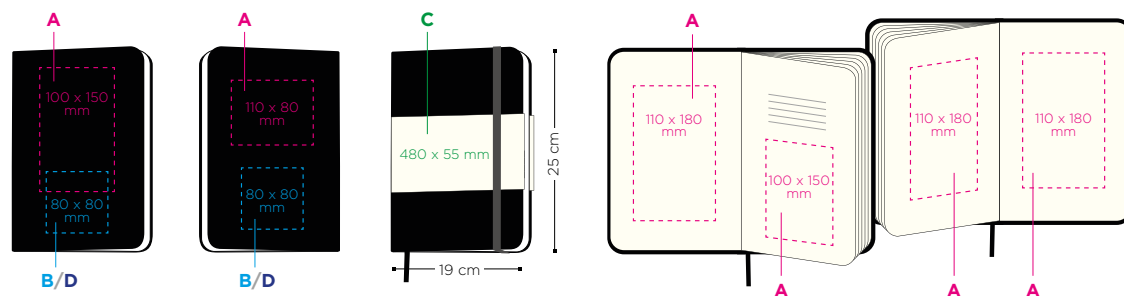

Interior pages:

- 96 15097
 - 96 15094
- Ivory-coloured 70 g/m² paper

Printing techniques:

- SP

(SP) SCREEN PRINTING
 - DB

(DB) DEBOSSING
 - DG

(DG) 4-COLOUR PROCESS
 - HS

(HS) HOT STAMPING
- BLACK
 - GOLD (871 C)
 - SILVER (877 C)
 - WHITE
 - TRANSPARENT





CLASSIC NOTEBOOK EXPANDED 13 X 21 CM

15105

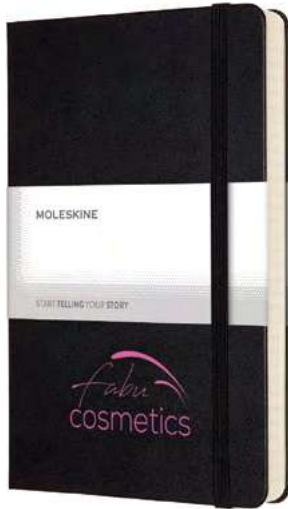

More pages
for more content.
400 pages. 2 bookmarks.



BLACK*

Also available
in hard cover

Minimum order quantity 25 v.

Customization:

- A SP:** max. 1 col.
- B DB:** Transparent
- C DG:** Paperband, CMYK
- D HS:** max. 1 col.

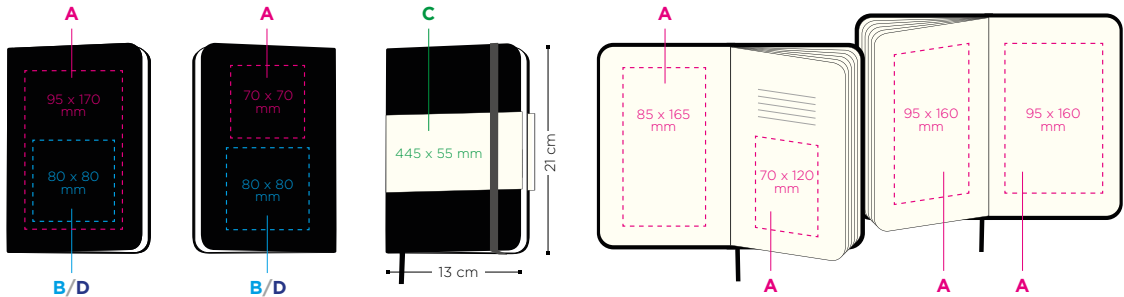

Interior pages:

400

Ivory-coloured 70 g/m² paper

*While stocks last

Printing techniques:



(SP) SCREEN
PRINTING



(DB) DEBOSSING



(DG) 4-COLOUR
PROCESS



(HS) HOT
STAMPING

- BLACK
- GOLD (871 C)
- SILVER (877 C)
- WHITE
- TRANSPARENT





CLASSIC NOTEBOOK MEDIUM 11.5 X 18 CM

15107 

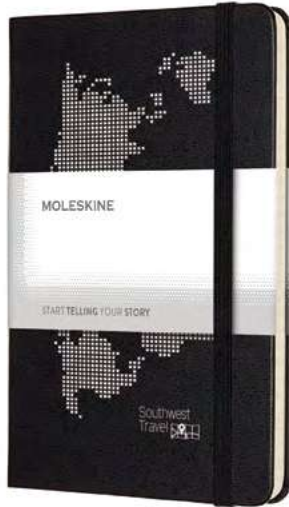

XL NOTEBOOK
19 X 25 CM

LARGE NOTEBOOK
13 X 21 CM

POCKET NOTEBOOK
9 X 14 CM

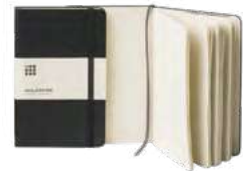

MEDIUM NOTEBOOK <
11.5 X 18 CM



BLACK *

Minimum order quantity 25 v.

Customization:

- A SP:** max. 1 col.
- B DB:** Transparent
- C DG:** Paperband, CMYK
- D HS:** max. 1 col.

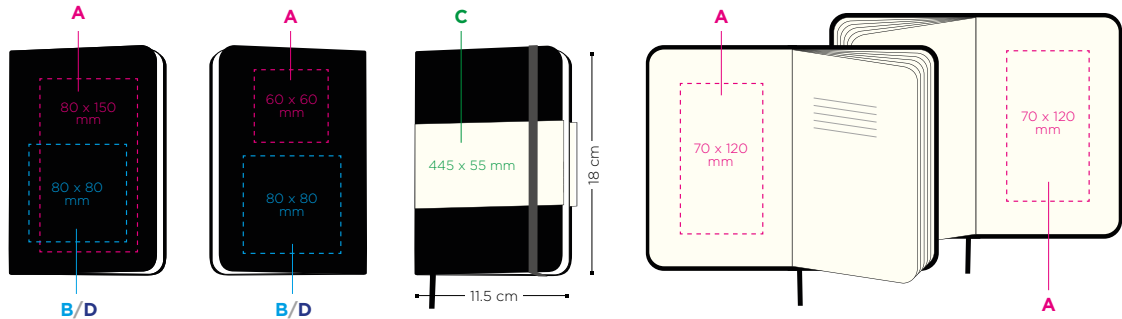

Interior pages:

208 

Ivory-coloured 70 g/m² paper

*While stocks last

Printing techniques:



(SP) SCREEN PRINTING







(DB) DEBOSSING



(DG) 4-COLOUR PROCESS



(HS) HOT STAMPING

-  BLACK
-  GOLD (871 C)
-  SILVER (877 C)
-  WHITE
-  TRANSPARENT





CAHIERS JOURNALS

15076

POCKET 9 X 14 CM

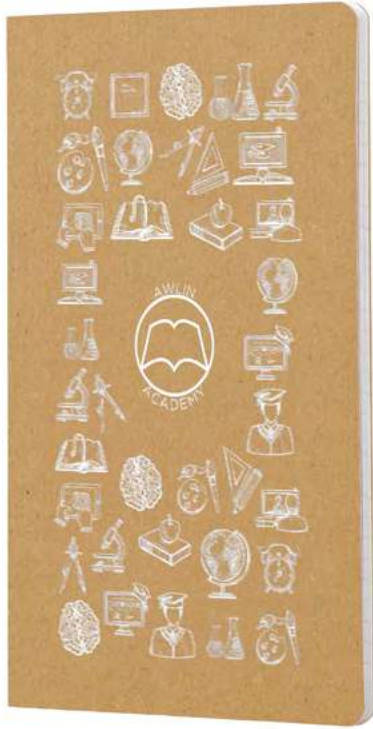

Cardboard cover

Last 16 sheets detachable

15067

LARGE 13 X 21 CM

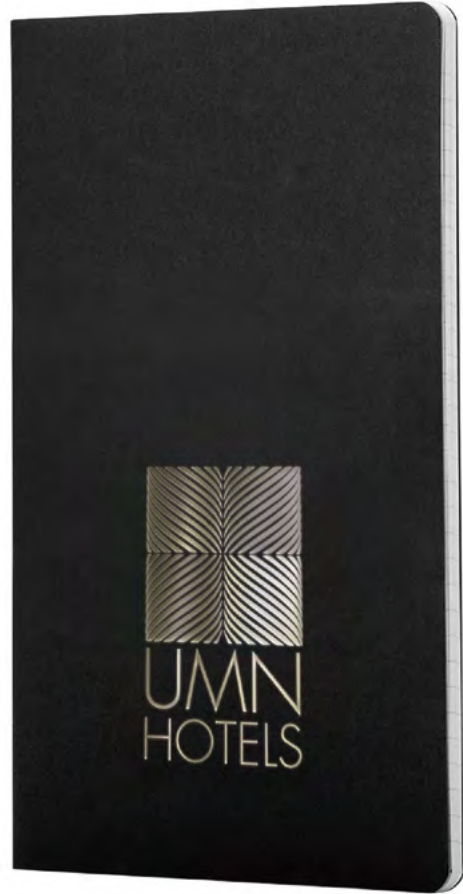

POCKET - 15076



BLACK KRAFT BROWN*

OTHER OPTIONS UNDER REQUEST



INDIGO BLUE PLAIN PAPER

LARGE - 15067

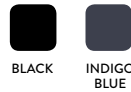

BLACK INDIGO BLUE

LARGE - 15067



CRANBERRY RED* INDIGO BLUE*

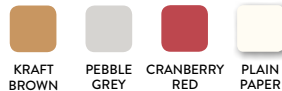

KRAFT BROWN PEBBLE GREY CRANBERRY RED PLAIN PAPER

*While stocks last

Minimum order quantity 100 v.

Customization:

- A SP:** max. 1 col.
- B HS:** max. 1 col.
- C DB:** Transparent

Pocket
15076

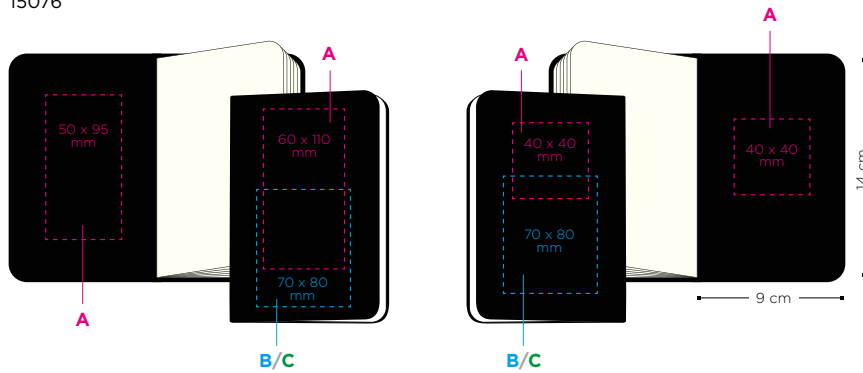

Large
15067

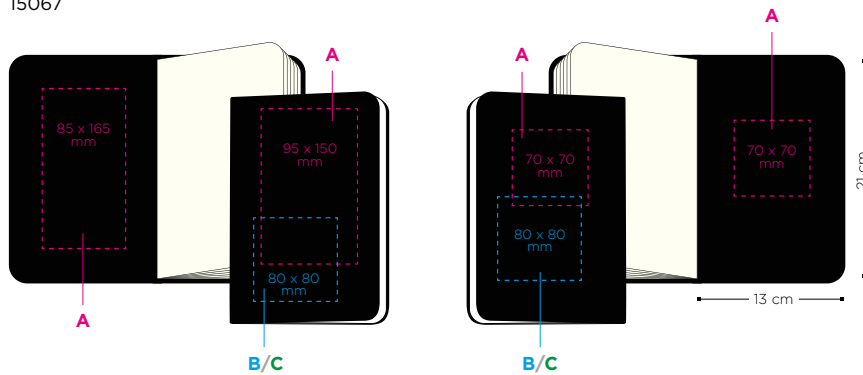

Interior pages:

- 64  15076
- 80   15067

Ivory-coloured 70 g/m² paper

Printing techniques:







(SP) SCREEN PRINTING



(DB) DEBOSSING



(HS) HOT STAMPING

-  BLACK
-  GOLD (871 C)
-  SILVER (877 C)
-  WHITE
-  TRANSPARENT





PASSION JOURNAL

Unique gift to document your interests and life's key moments

15109

LARGE 13 X 21 CM



WINE

Write your own wine guide

WINE JOURNAL*

15113

LARGE 13 X 21 CM

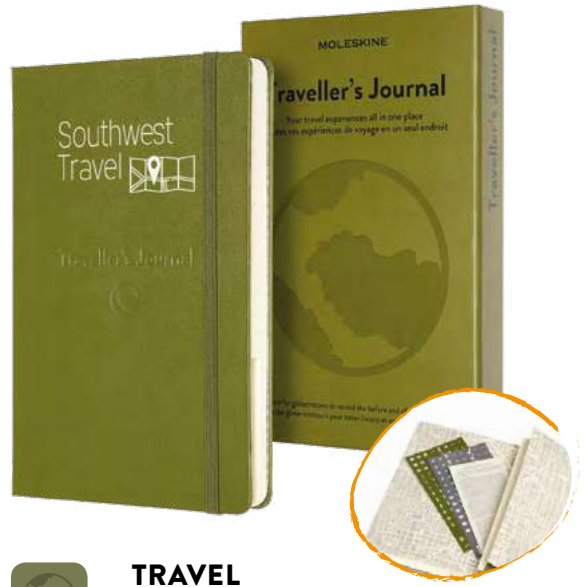

TRAVEL

Your best travel experiences all in one place

TRAVEL JOURNAL*

Minimum order quantity 16 v.

Customization:

- A SP:** max. 1 col.
- B HS:** max. 1 col.
- C DB:** Transparent

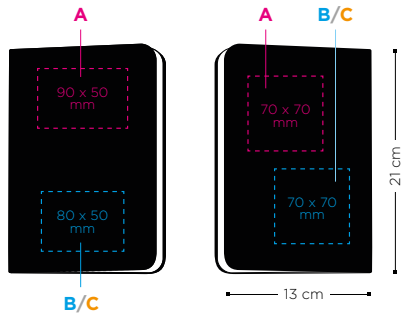

Interior pages:

400 70 g/m² paper

Other options under request:



RECIPE JOURNAL



WELLNESS JOURNAL

Check MOQ and prices

*While stocks last

Printing techniques:



(SP) SCREEN PRINTING



(DB) DEBOSSING



(HS) HOT STAMPING

- BLACK
- GOLD (871 C)
- SILVER (877 C)
- WHITE
- TRANSPARENT



GIFTBOX MOLESKINE

Complete the gift with this elegant box

12016  SOFT COVER NOTEBOOK SET

12017  HARD COVER NOTEBOOK SET



BLACK*

1. Choose and customize a Classic Large Notebook
2. Combine it with a Moleskine Pen
3. Customize the Giftbox

Notebook
& pen set

Minimum order quantity 25 u.

Customization:

A SP: max. 1 col.

B HS: max. 1 col.

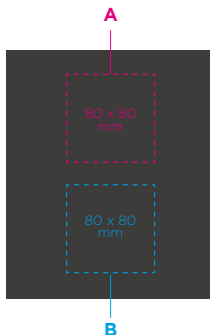

Printing techniques:



(SP) SCREEN PRINTING



(HS) HOT STAMPING

- BLACK
- GOLD (871 C)
- SILVER (877 C)
- WHITE
- TRANSPARENT

*While stocks last



SMART WRITING SET

Digitize your ideal in real time

15104



New Smart Pen 3: a sleek shape designed to be held comfortably. Exclusive dedicated Smart Pen charger.

APP NOTES 2.0
New and Improved!



Minimum order quantity 1 v.

Customization:

- A DB: Transparent
- B HS: max. 1 col.
- C BP: britePix™

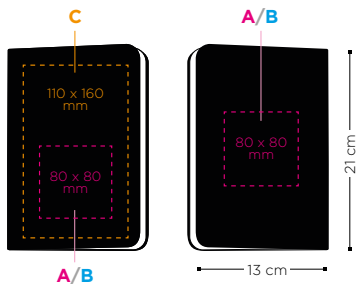

Your Smart Writing Set always comes with:

- Smart Notebook with Ncoded paper designed to work with the Smart Pen
- Smart Pen
- Pen tip ink refill
- Magnetic charger

Printing techniques:

DB	BP	HS	<input checked="" type="checkbox"/> BLACK
(DB) DEBOSSING	(BP) britePix™	(HS) HOT STAMPING	<input type="checkbox"/> GOLD (871 C)
			<input type="checkbox"/> SILVER (877 C)
			<input type="checkbox"/> WHITE
			<input type="checkbox"/> TRANSPARENT



Interior pages:

176 15104 100 g/m² paper



BUSINESS BACKPACK

Your mobile workspace

15108



Identification label inside

Trolley strap + hidden security zipper



Easy-access pockets for small items



Your mobile workspace.

Boost productivity on the move.

Created for anyone who spends a lot of time traveling, this hardworking backpack features practical pockets and compartments to store and secure documents, devices (up to 15"), notebooks, and all types of accessories.

Minimum order quantity 8 u.

Customization:

SP: max. 1 col.

Printing technique:



(SP) SCREEN PRINTING



*While stocks last



Images are for visual representation only.
We reserve the right to change product configurations at any time.